

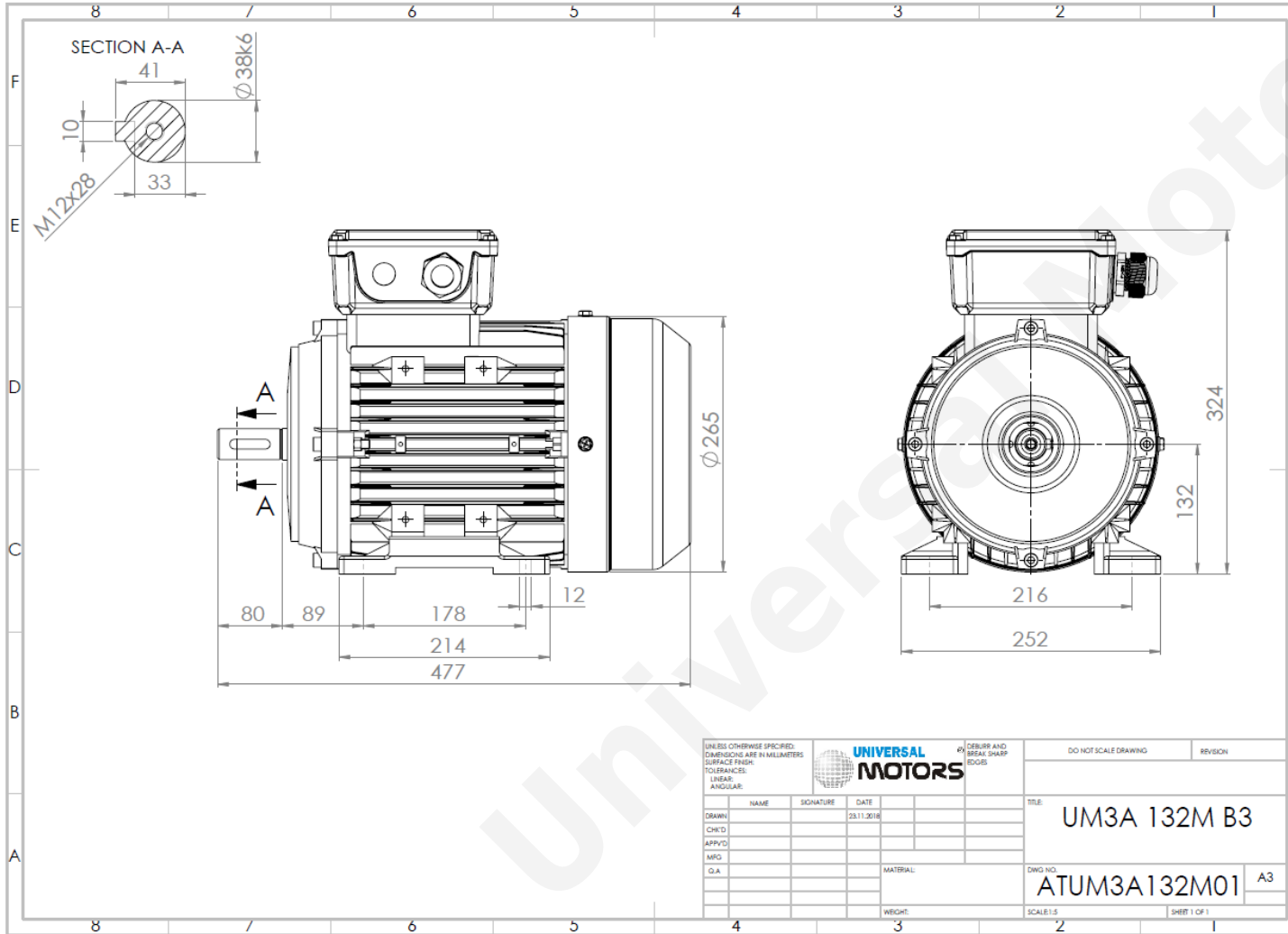

TECHNICAL DATA

Three Phase Electric Motors - Aluminum Frame
 PE31 132M1-6
 4.0 kW / 5.5 Cv
 965 RPM



Motor type:	PE31 132M1-6
Output:	4.0 kW / 5.5 Cv
Speed (min ⁻¹):	965 RPM
Frequency:	50 Hz
Voltage:	400 V
Current:	9.0 A
Power factor (Cos Ø):	0.74
Poles:	6
Insulation class:	F
Temperature rise Class:	B
Efficiency 50%:	84.6 %
Efficiency 75%:	87.1 %
Efficiency 100%:	86.8 %
Torque:	39.6 N.m
Tstarting/Tnominal:	2.0
Istarting/Inominal:	6.8
Tmaximum/Tnominal:	2.1
Noise:	73 Db(A)
Weight:	51.0 Kg
Bearing DE:	6308 2Z C3
Bearing NDE:	6308 2Z C3

Regime - S1

Altitude - 1000m

Environment Temperature - 40°C

CONTACTS:

UNIVERSAL MOTORS Tel: +351 252 299 080
 Rua de São Brás,745 Fax: +351 252 299 089
 4480-782 VILA DO CONDE Mail: geral@universalmotors.pt

* References applied only in the UK